

BILSTEIN Advanced High Strength Low Alloy (AHSLA)

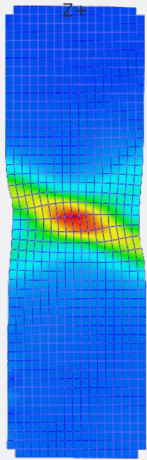

Material characterisation
CR600LA

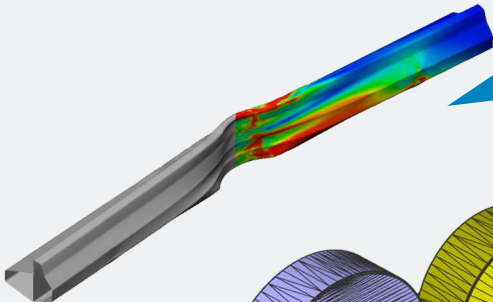

Crashsimulation
CR970LA

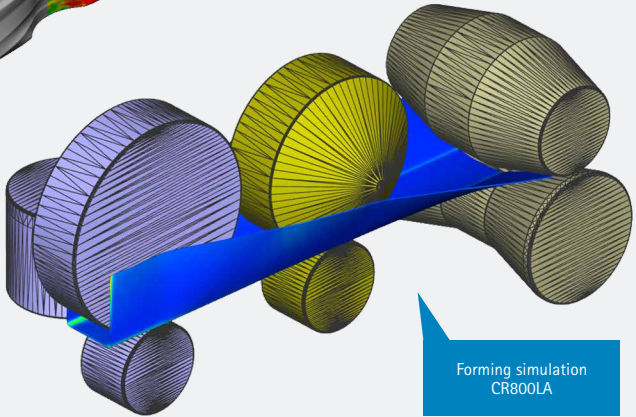

Forming simulation
CR800LA

engineered by BILSTEIN GROUP *Das Kaltband.*

BILSTEIN

Advanced High Strength Low Alloy (AHSLA)

With advanced microalloyed cold rolled steel grades, yield strengths between 500–1000 MPa can be achieved due to specific rolling and heat treatment strategies. Thus, this group of materials is suitable for cold forming of highly loaded components and offers high lightweight potential.

NOTATION, STANDARDS AND MECHANICAL PROPERTIES

VDA 239-100*	EN 10268*	SAE J2340	BILSTEIN- Company- standard	R _{p min} [MPa]	R _m [MPa]	A ₈₀ [%]
CR500LA	HC540LA	490R	ZE500	500	540 - 690	13
CR550LA	HC590LA	550R	ZE550	550	590 - 740	12
CR600LA	HC650LA	-	ZE600	600	630 - 780	11
CR700LA	HC750LA	700R	ZE700	700	730 - 880	10
CR800LA	HC860LA	-	ZE800	800	830 - 980	8
CR900LA	HC970LA	-	ZE900	900	920 - 1070	7
CR1000LA	HC1070LA	-	ZE1000	1000	1020 - 1170	5

*based on

Values in longitudinal direction

Depending on the thickness, mechanical properties can exceed the specified limits.

At the customer's request, smaller ranges or individual intermediate stages can also be agreed after technical discussion.

The chemical composition of these grades corresponds to the standard of DIN EN 10268. In addition to a worldwide material availability those grades provide excellent weldability with all common processes due to the low C-equivalent.

CHEMICAL COMPOSITION

C	Si	Mn	P	S	Al	Ti	Nb	CEV
max. %	max. %	max. %	max. %	max. %	max. %	max. %	max. %	max. %
0.13	0.6	1.8	0.03	0.015	0.015	0.15	0.09	0.3

Due to the single-phase microstructure outstanding homogeneous material properties can be achieved with positive effects, for example with regard to the beneficial hole expansion ratios. Furthermore, high yield-to-tensile ratios of >95% also offer best conditions for cold forming processes like of roll forming.

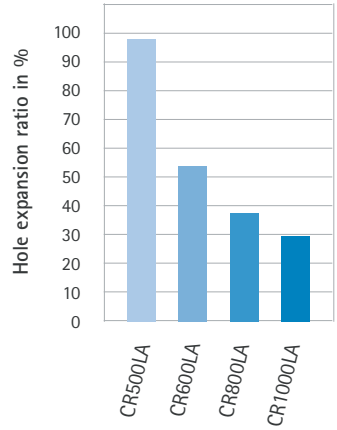
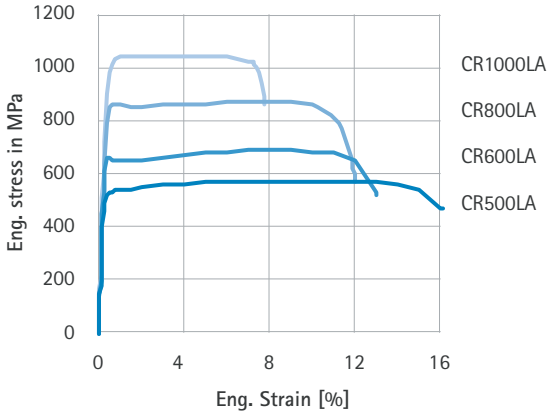

THICKNESS RANGE

t	0.25	0.50	0.75	1.00	1.25	1.50	1.75	2.00	2.25	2.50	2.75	3.00	3.25	3.50	3.75	4.00	4.25	4.50	4.75	5.00	
CR500LA																					
CR550LA																					
CR600LA																					
CR700LA																					
CR800LA																					
CR900LA																					
CR1000LA																					
Tolerance	±0.030			±0.035			±0.040			±0.045			±0.050			±0.055					

Values in mm

BILSTEIN AHSLA are available over a wide thickness range up to a width of 1350 mm. Typically, the grades are supplied with thickness and width tolerances in accordance with DIN EN 10140 and surfaces in accordance with DIN EN 10139. In addition to individual customer requirements for surfaces or tolerances, application-related individual mechanical properties, that deviate from the standard, can also be agreed.

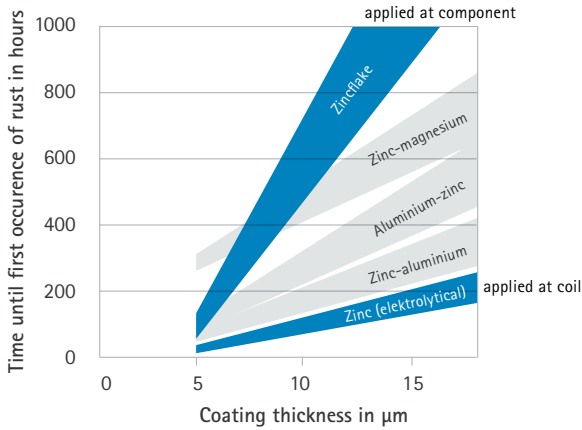

To protect the surfaces, metallic coatings can be applied electrolytically to the coils. Alternatively, highly corrosion-resistant zinc flake coatings as well as wet and powder coatings can be applied to the component or final product.

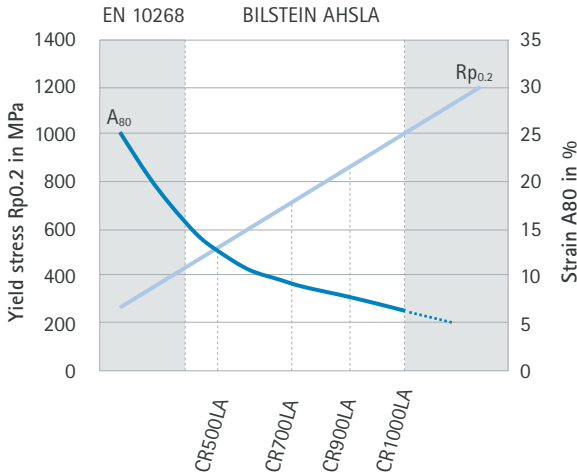

Due to the mentioned properties these high-strength materials are already meeting the high requirements of the automotive industry for years now. Currently they are used, for example, in seating structures, airbag systems or transmission transmission components.



BILSTEIN AHSLA will continue to demonstrate its advantages in the future with regard to lightweight applications in electromobility as well as the availability of CO₂-reduced variants.

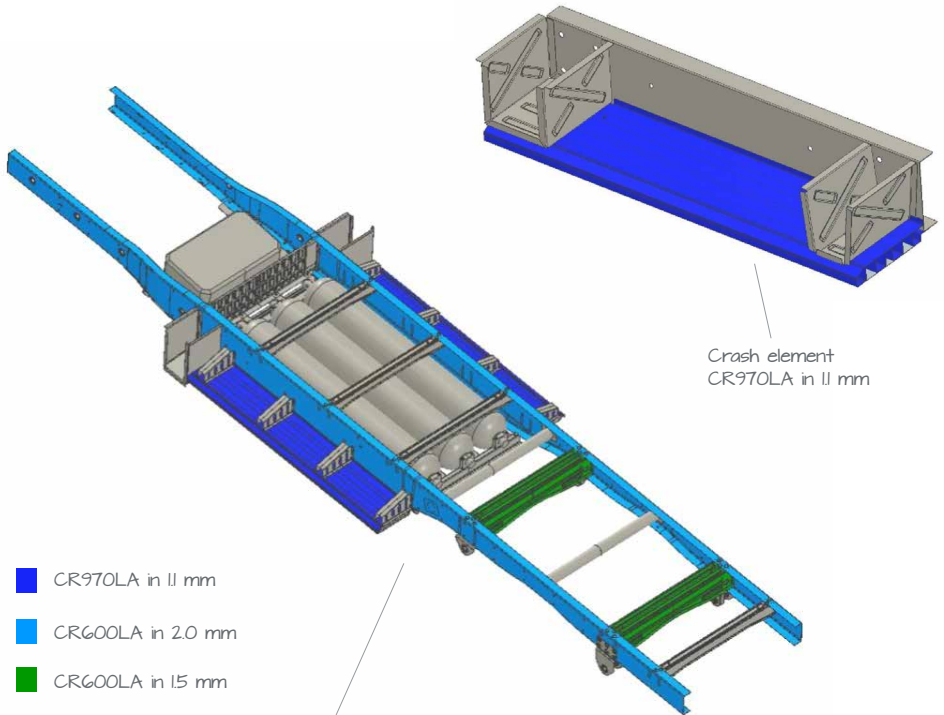

Crash element
CR970LA in 11 mm

- CR970LA in 11 mm
- CR600LA in 2.0 mm
- CR600LA in 15 mm

Underbody assembly of light commercial vehicle
FCEV variant - publicly funded project «FlexHyBat»



Im Weinhof 36 | 58119 Hagen | Germany

Contact Partner | **Dr.-Ing. Christoph Dahnke**
Head of Application Services
Application Services and Development

T +49 2334 82-2501
christoph.dahnke@bilstein-kaltband.de
bilstein-gruppe.de/en

